

YAYLI PANO KİLİDİ
QUARTER TURN WITH SPRING

060



PASLANMAZ STAINLESS STEEL

Diller için bak. sayfa-> 36
For cams page -> 36

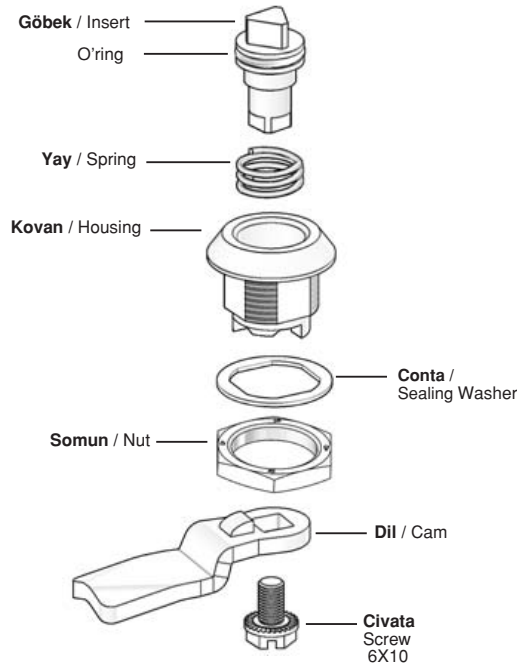
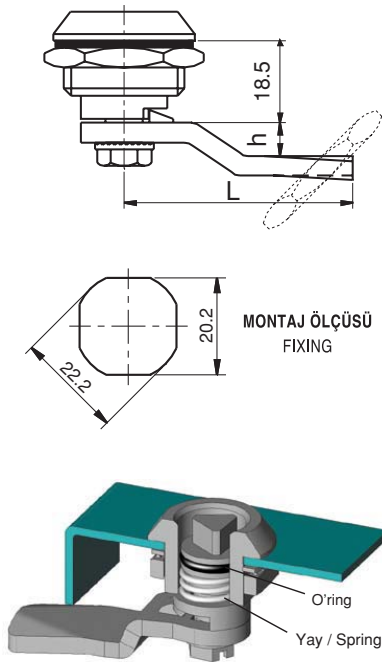

ÜRÜN KODU / PRODUCT CODE

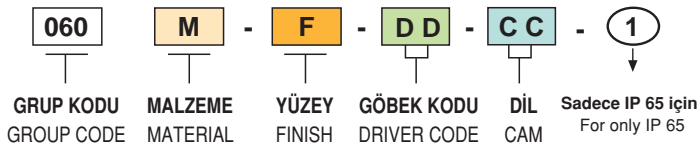

KOD / CODE	MALZEME / MATERIAL	M	YÜZEY / FINISH	F
060 1-1-DD-CC	Zamak	1	Krom / Chrome	1
060 1-2-DD-CC			Siyah boya / Black Coated	2
060 2-0-DD-CC	Plastik / Polyamide	2	Kaplamasız / No Finish	0
060 4-0-DD-CC	Paslanmaz / Stainless Steel	4	Kaplamasız / No Finish	0

* Lütfen standart dışı isteklerinizde aşağıdaki kodlamayı kullanınız.

* For mixed material and finish lock orders please use below coding system

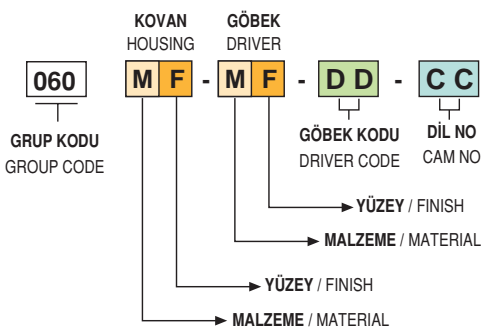

ÖRNEK / EXAMPLE

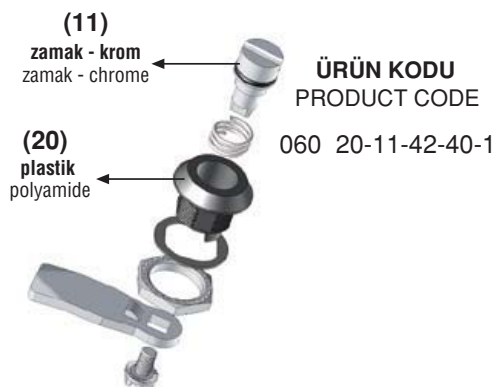

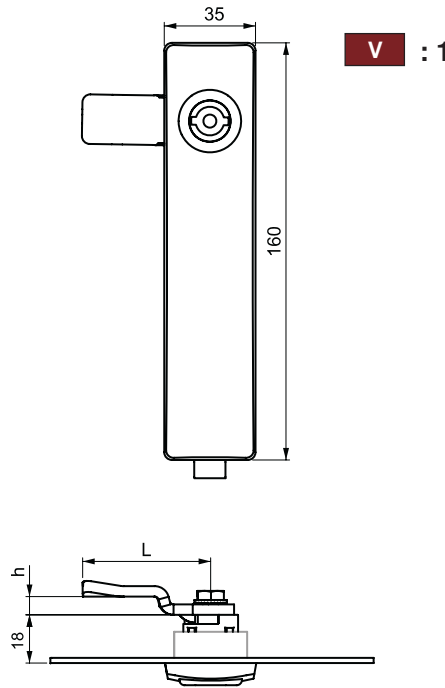
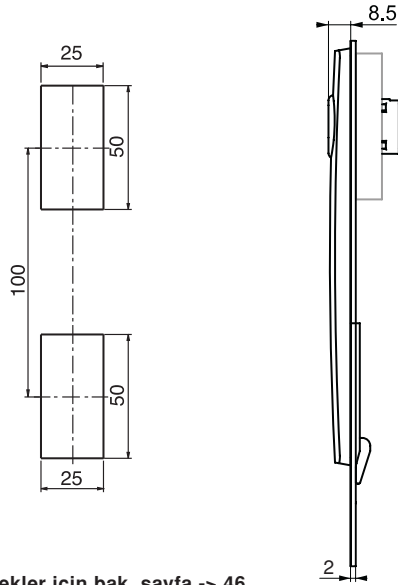

KARE KAPAKLI PANO KİLİDİ
SQUARE BASE QUARTER TURN

203

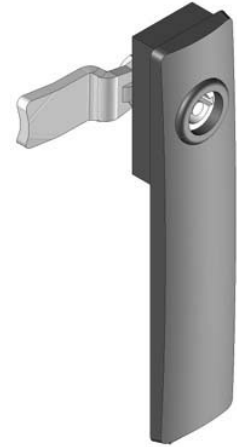

IP 65

Göbekler için bak. sayfa -> 46
For driver options page -> 46

Diller için bak. sayfa-> 36
For cams page -> 36

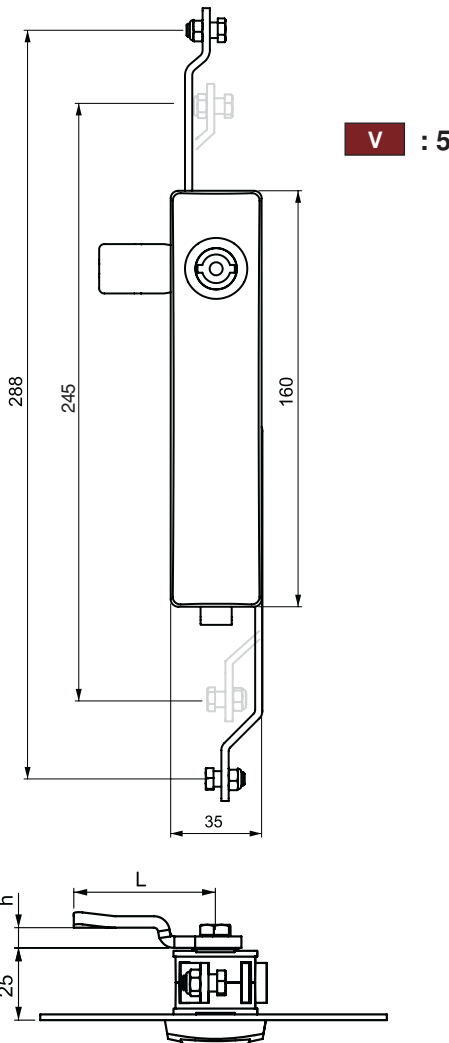
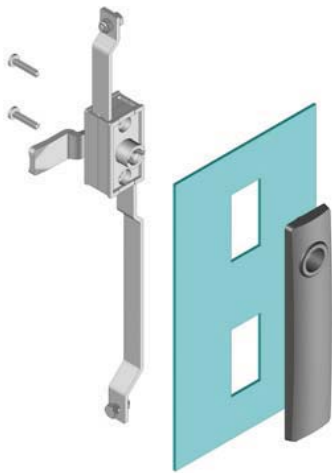































































İSPANYOLET SİSTEMLİ PANO KİLİDİ
3 POINTS LOCK

203



IP 65

GÖBEKLER DRIVER	5 mm	8 mm	9 mm
DD	15	28	39

GÖBEKLER DRIVERS	DD	ZAMAK-KROM KAPLAMALI ZAMAK -CHROME PLATED	ZAMAK-BOYALI ZAMAK BLACK COATED	PLASTİK POLYAMIDE	PASLANMAZ STAINLESS STEEL
	13				
	15				
	26				
	27				
	28				
	37				
	38				
	39				
	42				
	58				
	61				
	68				
	71				
	76				
	88				
	91				
	92				

KOVANLAR / HOUSINGS

ZAMAK-KROM / ZAMAK -CHROME

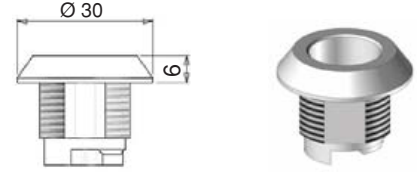

ZAMAK-BOYALI / ZAMAK - BLACK COATED

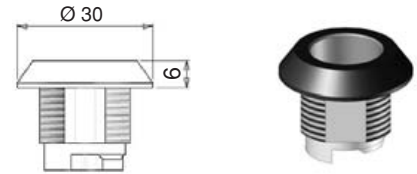

PLASTİK / POLYAMIDE

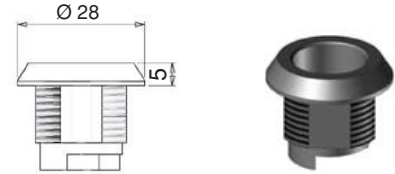

PASLANMAZ / STAINLESS STEEL

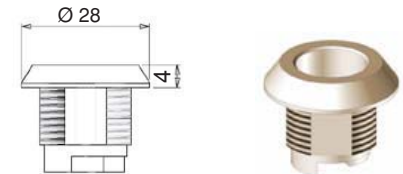

SOMUNLAR / NUTS

PLASTİK
POLYAMIDE

ZAMAK- ÇİNKO KAPLAMALI
ZAMAK -ZINK PLATED

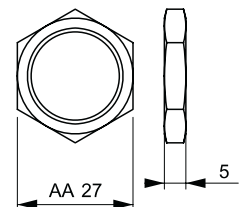

MANDALLI KAPAK KİLİDİ
COVER LOCK

064

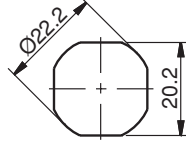
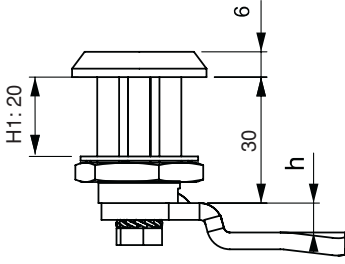

MONTAJ ÖLÇÜSÜ
FIXING

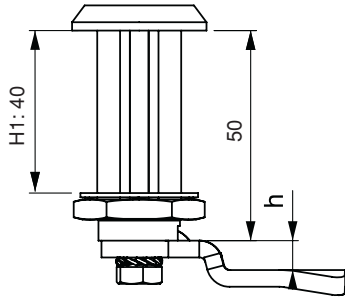
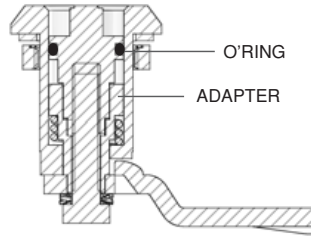
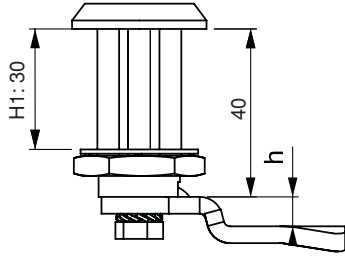

Göbekler için bak. sayfa -> 46
For driver options, page -> 46

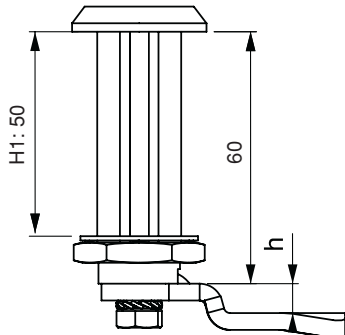

ÜRÜN KODU / PRODUCT CODE

064	DD	-	H1	-	CC
GRUP KODU GROUP CODE	GÖBEK KODU DRIVER CODE		KAPI KALINLIĞI THICKNES DOOR		DİL CAM



UYGULAMA ALANLARI

Ahşap kapaklar, izolasyonlu kapaklar

MALZEME

KOVAN : Zamak DIN-EN 1774-ZnAl4Cu1
GÖBEK : Zamak DIN-EN 1774-ZnAl4Cu1
DİL : Çelik
CONTA : Kauçuk
YÜZEY : Krom

APPLICATIONS

Wooden panels, isolated covers

MATERIAL

HOUSING : Zamak DIN-EN 1774-ZnAl4Cu1
DRIVER : Zamak DIN-EN 1774-ZnAl4Cu1
CAM : Steel or PA
GASKET : Rubber
FINISH : Chrome

İsteğe göre IP 65 (O'ring)
sızdırmazlık özelliklerinde üretilmektedir.
O'ring takılması istenirse;
064-DD-H1-CC numaraları
yazıldıktan sonra sonuna (1)
eklenmelidir. Ör: 064-28-25-1

IP 65 is optional.
When you order please add (1)
after the product code
064-DD-H1-CC
Exp. 064-28-25-1



Diller için bak. sayfa-> 36
For cams page -> 36

YAYLI PANO KİLİDİ
SECURE QUARTER TURN

361

NEW



UYGULAMA ALANLARI

Elektrik panoları, makina kapakları

MALZEME

KOVAN : Zamak DIN-EN 1774-ZnAl4Cu1
GÖBEK : Zamak DIN-EN 1774-ZnAl4Cu1
DİL : Çelik
CONTA : Kauçuk
YÜZEY : Krom veya siyah boya

APLICATIONS

Electric panels, machinery covers

MATERIAL

HOUSING : Zamak DIN-EN 1774-ZnAl4Cu1
DRIVER : Zamak DIN-EN 1774-ZnAl4Cu1
CAM : Steel or PA
GASKET : Rubber
FINISH : Chrome or black coated

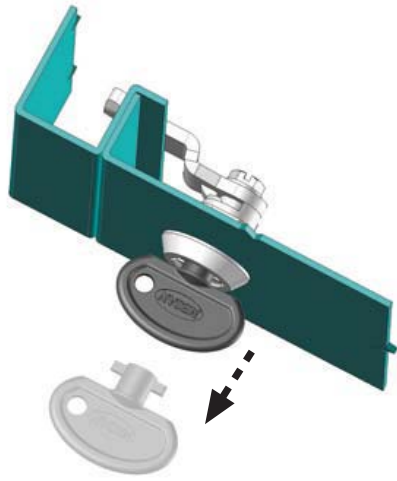
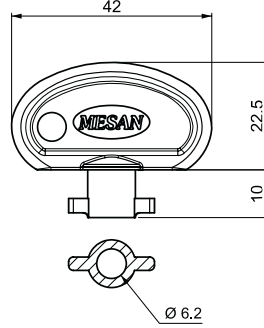
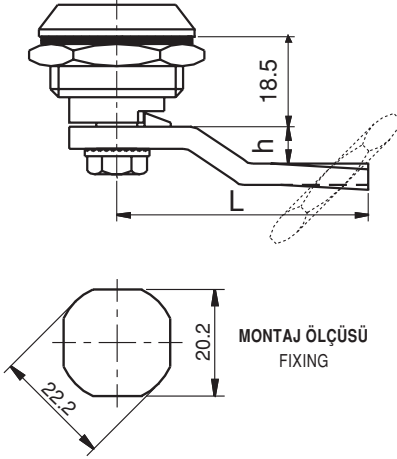

Kilit kapalı konumda anahtar çıkar.

Key is removable at locked position

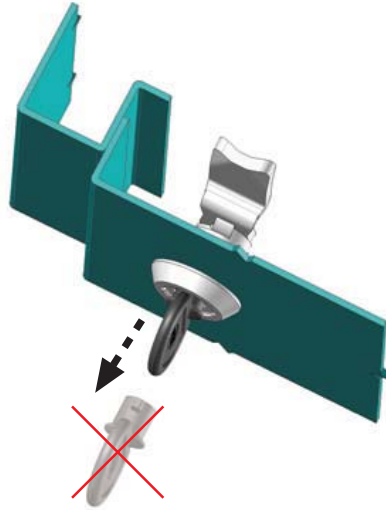

Kilit açık konumda anahtar çıkmaz.

Key is not removable at open position,
it works like a knob.

Kilit / Lock

Anahtar / Key

ÜRÜN KODU / PRODUCT CODE

361

1

F

CC

GRUP KODU
GROUP CODE

MALZEME
MATERIAL

YÜZEY
FINISH

DİL
CAM

ÜRÜN KODU / PRODUCT CODE

167

1

F

GRUP KODU
GROUP CODE

MALZEME
MATERIAL

YÜZEY
FINISH

MALZEME / MATERIAL	M
Zamak	1

YÜZEY / FINISH	F
Krom / Chrome	1
Siyah boya / Black Coated	2

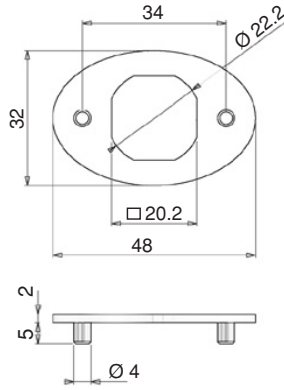
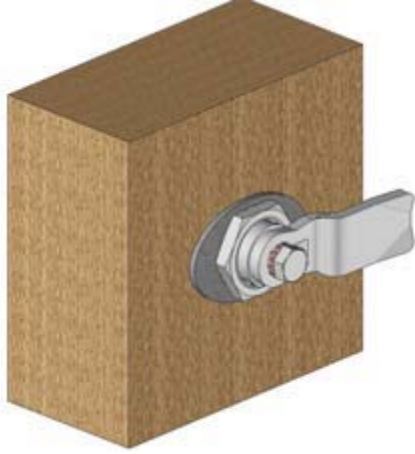

SABİTLEYİCİ
FIXING DEVICE

060 A5



UYGULAMA ALANLARI

Ahşap kapaklar

MALZEME

Zamak DIN-EN 1774-ZnAl4Cu1

YÜZEY : Çinko

APPLICATIONS

Wooden panels

MATERIAL

Zamak DIN-EN 1774-ZnAl4Cu1

FINISH : Zinc plated

AYAR TAŞI
SPACER

060 A6

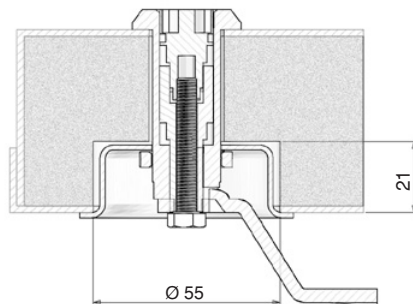
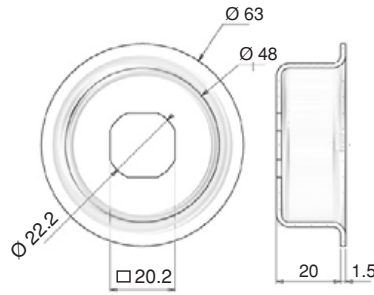

UYGULAMA ALANLARI

İzolasyonlu kapaklar

MALZEME

Çelik

YÜZEY : Çinko kaplama

APPLICATIONS

Isolated covers

MATERIAL

Steel

FINISH : Zinc plated