

BİLYALI PANO KİLİDİ
CAM LOCK WITH BALL

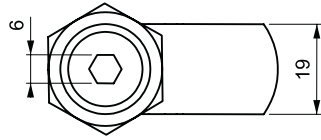

052 - **CC**
GRUP KODU DİL NO
GROUP CODE Cam NO

052

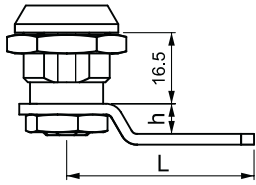
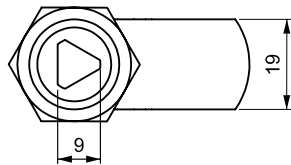
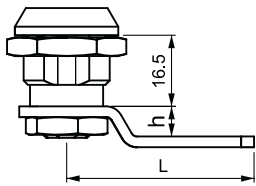

053 - **CC**
GRUP KODU DİL NO
GROUP CODE Cam NO

053

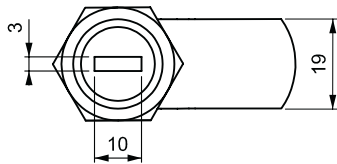
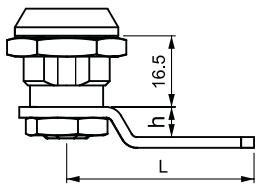

054 - **CC**
GRUP KODU DİL NO
GROUP CODE Cam NO

054

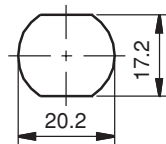

052-053-054
MONTAJ ÖLÇÜSÜ
FIXING

UYGULAMA ALANLARI

Elektrik panoları, makine kapakları

MALZEME

KOVAN : Zamak DIN-EN 1774-ZnAl4Cu1

DİL : Çelik

YÜZEY : Krom

APPLICATIONS

Electric panels, machinery covers

MATERIAL

HOUSING : Zamak DIN-EN 1774-ZnAl4Cu1

CAM : Steel

FINISH : Chrome

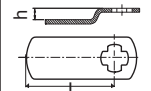
DİLLER / CAMS		10	11	12	20	21	22	30
	h	0	3	7	0	7	10	0
	L	39	38	36	49	47	44	33

MANDALLI KİLİT
CAM LOCK

050



UYGULAMA ALANLARI

Çelik masa, çelik dolap, posta kutusu ve makina kapakları

MALZEME

KOVAN : Zamak DIN-EN 1774-ZnAl4Cu1
DİL : Çelik
YÜZEY : Krom

APPLICATIONS

Briefcases, steel drawers, machinery covers

MATERIAL

HOUSING : Zamak DIN-EN 1774-ZnAl4Cu1
CAM : Steel
FINISH : Chrome

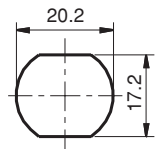

Version 1,2,3,4,9 MONTAJ ÖLÇÜSÜ
Fixing

Versiyon 3-4-5-6-7-9'da
Kilit montaj yuvasına dili
çıkartılmadan takılır.

Version 3-4-5-6-7-9
No need to remove
the cam for fixing

Açık konumda anahtar çıkamaz
özellği 90° dönüşlü tüm versiyonlarda
isteğe göre uygulanabilir.

Non removable key is optional at
90° key rotation

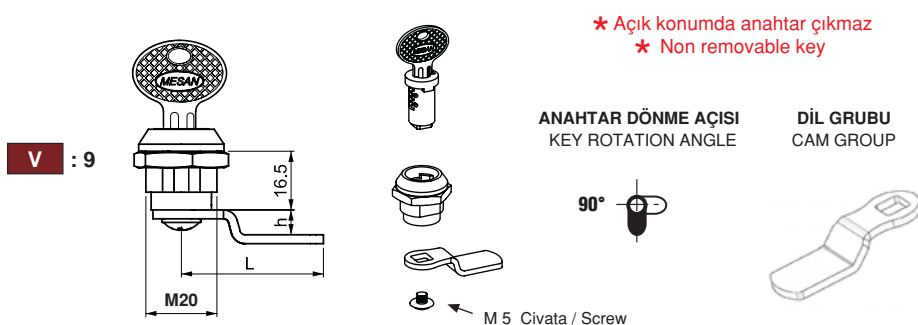
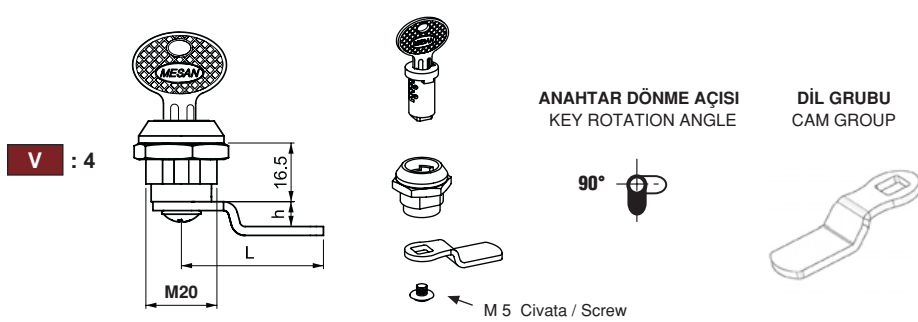
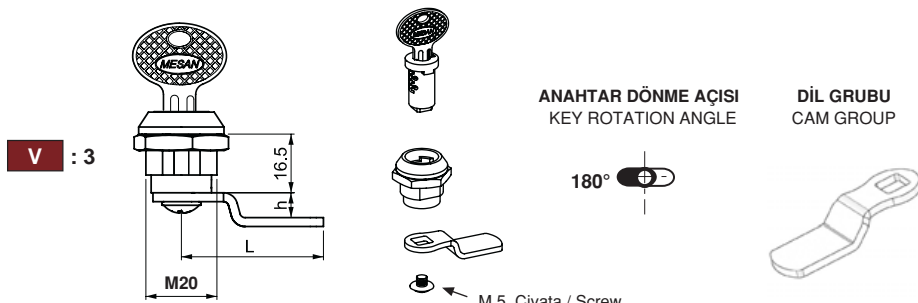
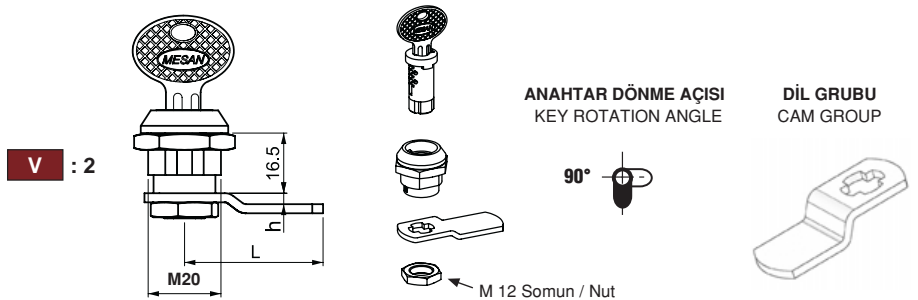
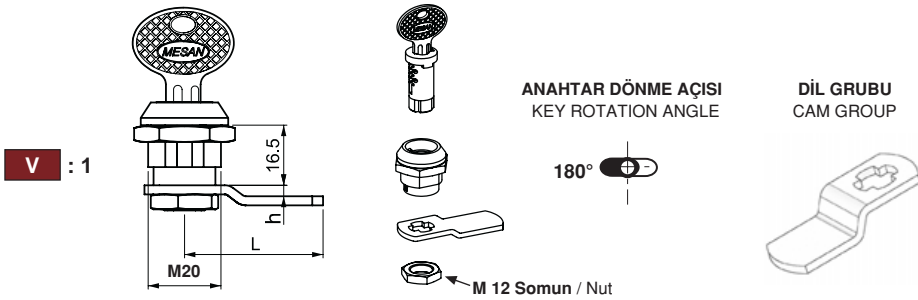

MANDALLI KİLİT
CAM LOCK

050



Paslanmaz toz kapaklı
Stainless steel dust cap



UYGULAMA ALANLARI

Çelik masa, çelik dolap, posta kutusu ve makina kapakları

MALZEME

KOVAN : Zamak DIN-EN 1774-ZnAl4Cu1

DİL : Çelik

YÜZEY : Krom

APPLICATIONS

Briefcases, steel drawers, machinery covers

MATERIAL

HOUSING : Zamak DIN-EN 1774-ZnAl4Cu1

CAM : Steel

FINISH : Chrome

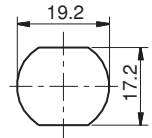

Version 5,6,7, MONTAJ ÖLÇÜSÜ
FIXING



Kancalı dil / hook cam : h: 0 x L: 39

C C → 13

V : 5

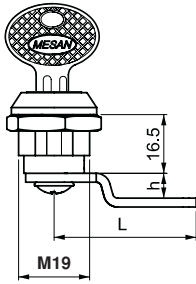

ANAHTAR DÖNME AÇISI
KEY ROTATION ANGLE

DİL GRUBU
CAM GROUP



M 5 Civata / Screw

V : 6

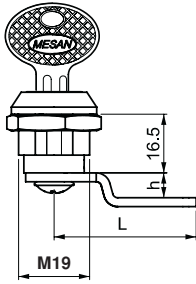

ANAHTAR DÖNME AÇISI
KEY ROTATION ANGLE

DİL GRUBU
CAM GROUP



M 5 Civata / Screw

V : 7

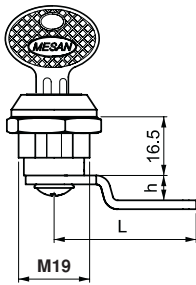

* Açık konumda anahtar çıkmaz
* Non removable key

ANAHTAR DÖNME AÇISI
KEY ROTATION ANGLE

DİL GRUBU
CAM GROUP



M 5 Civata / Screw

ÜRÜN KODU / PRODUCT CODE

050	V	DD	CC
GRUP KODU GROUP CODE	VERSİYON VERSION	FİŞE CYLINDER	DİL CAM

Fişe / Cylinder	ÖZELLİKLER / SPECIFICATIONS	DD
	Aynı şifre (Birbirini açan) / Keyed alike	01
	Farklı şifre (Birbirini açmayan) / Keyed differ	02
	Paslanmaz toz kapaklı fişe (Birbirini açan) / Stainless steel dust cap Keyed alike	03
	Paslanmaz toz kapaklı fişe (1000 Birbirini açmayan) / Stainless steel dust cap Keyed differ (1000)	32
	Euro Key (5333) Stainless steel dust cap	05
	Euro Key (5333)	06

M 12 somun ile / M 12 Nut								M5 civata ile / M 5 Screw									
C C →		10	11	12	20	21	22	30	C C →		50	51	52	53	56	57	30
	h	0	3	7	0	7	10	0		h	0	7	10	14	0	3	0
	L	39	38	36	49	47	44	33		L	43	40	37	33	23	48	33

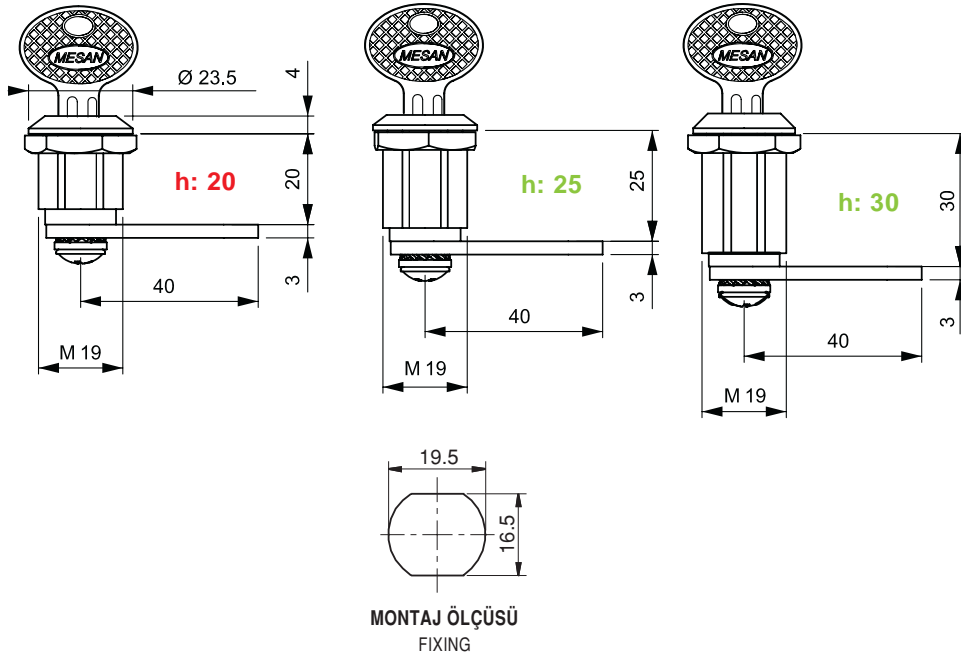

ÜRÜN KODU / PRODUCT CODE

050	h	-	DD	-	CC
GRUP KODU GROUP CODE	KOVAN BOYU HOUSING LENGHT		FİŞE CYLINDER		DİL CAM

Ürün / Product	ÖZELLİKLER / SPECIFICATIONS	DD
h: 25, 30	Aynı şifre (Birbirini açan) / Keyed alike	01
h: 25, 30	Farklı şifre (Birbirini açmayan) / Keyed differ	02
h: 20	Paslanmaz toz kapaklı fişe (Birbirini açan) / Stainless steel dust cap Keyed alike	03
h: 20	Paslanmaz toz kapaklı fişe (Birbirini açmayan) / Stainless steel dust cap Keyed differ	32

MANDALLI KİLİT
CAM LOCK

050



UYGULAMA ALANLARI

Çelik ve ahşap dolaplar

MALZEME

KOVAN : Zamak DIN-EN 1774-ZnAl4Cu1

DİL : Çelik

YÜZEY : Krom

APPLICATIONS

Steel drawers, wooden cupboard,

MATERIAL

HOUSING : Zamak DIN-EN 1774-ZnAl4Cu1

CAM : Steel

FINISH : Chrome



050 A1

CAM BAĞLANTI SACI
CAM LOCK FIXING
DEVICE - FOR GLASS



030 A1

KİLİT KARŞILIK SACI
LOCK FIXING DEVICE



050 A3

KİLİT TUTAMAĞI
HANDLE FOR LOCK

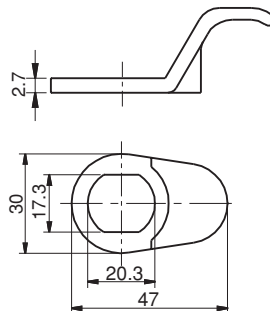
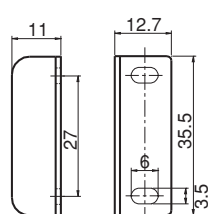
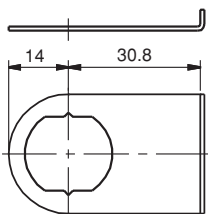

Diller için bak. sayfa-> 38
For cams page -> 38

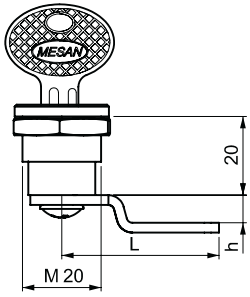

ANAHTAR DÖNME AÇISI
KEY ROTATION ANGLE



DİL GRUBU
CAM GROUP

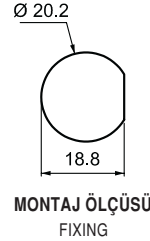

MONTAJ ÖLÇÜSÜ
FIXING

M 5 Civata / Screw

ÜRÜN KODU / PRODUCT CODE

150	20	-	DD	-	CC
GRUP KODU GROUP CODE	KOVAN BOYU HOUSING LENGHT		FİŞE CYLINDER		DİL CAM

MANDALLI KİLİT
CAM LOCK

150

NEW



250

NEW

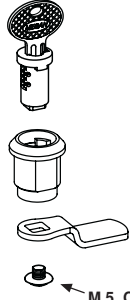
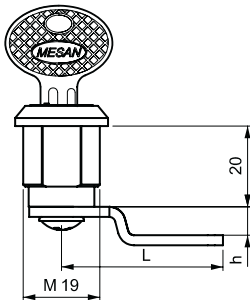

ANAHTAR DÖNME AÇISI
KEY ROTATION ANGLE



DİL GRUBU
CAM GROUP

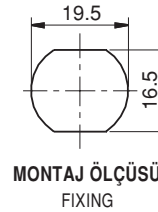

MONTAJ ÖLÇÜSÜ
FIXING

M 5 Civata / Screw

ÜRÜN KODU / PRODUCT CODE

250	20	-	DD	-	CC
GRUP KODU GROUP CODE	KOVAN BOYU HOUSING LENGHT		FİŞE CYLINDER		DİL CAM

UYGULAMA ALANLARI

Çelik masa, çelik dolap, posta kutusu ve makina kapakları

MALZEME

KOVAN : Zamak DIN-EN 1774-ZnAl4Cu1
DİL : Çelik
YÜZEY : Krom

APPLICATIONS

Briefcases, steel drawers, machinery covers

MATERIAL

HOUSING : Zamak DIN-EN 1774-ZnAl4Cu1
CAM : Steel
FINISH : Chrome

Fişe / Cylinder	ÖZELLİKLER / SPECIFICATIONS	DD
	Aynı şifre (Birbirini açan) / Keyed alike	01
	Farklı şifre (Birbirini açmayan) / Keyed differ	02



Diller için bak. sayfa-> 38
For cams page -> 38