

PRÆSTMARK A/S

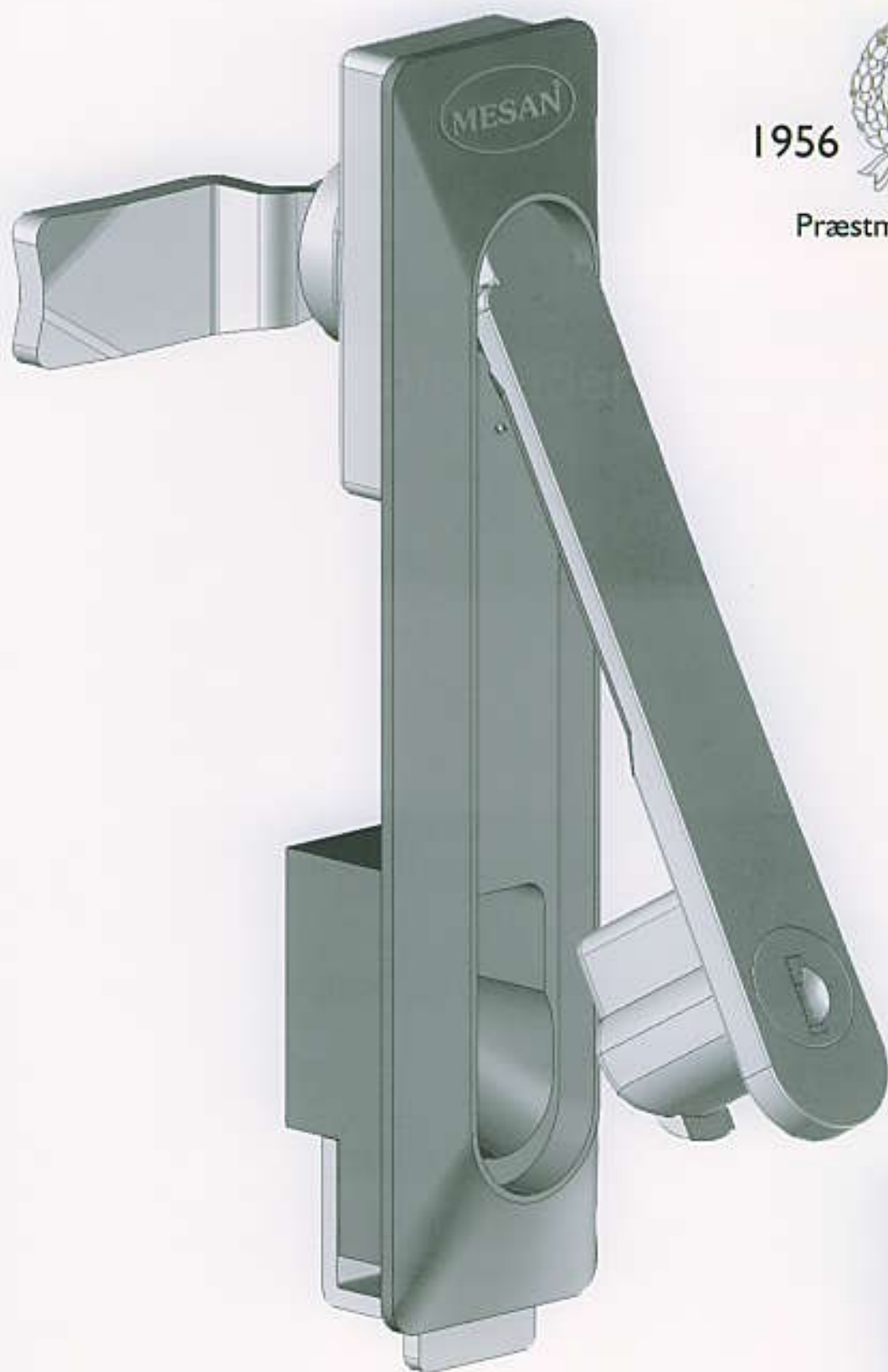

Præstmark - 50 år

- en verden af muligheder



EMKA og DIRAK Patenter er udløbet!

Specifikation	002	003	005	007	102	109
Ens lukkende	X		X	X	X	
Forskelligt lukkende	X		X	X	X	
Rustfri støvkappe - Ens lukkende			X	X		X
Rustfri støvkappe - Forskelligt lukkende			X	X		X
Hovednøglesystem (250 x 4) /Rustfri støvkappe	X		X	X	X	X
Euro Nøgle (5333) Rustfri støvkappe	X		X	X	X	X
Indsats						
5 mm dobbeltbart	X	X	X	X	X	X
8 mm firkant	X	X	X	X	X	X
9 mm trekant	X	X	X	X	X	X

MESAN®

Svinggreb type 002

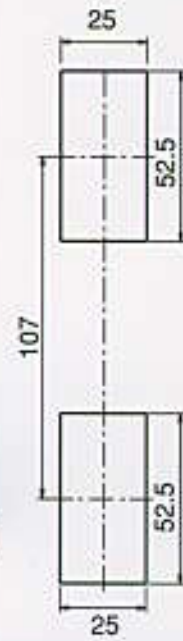

Svinggreb type 003

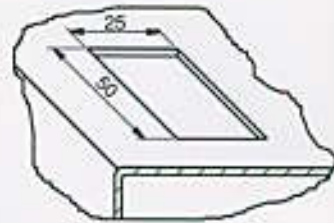
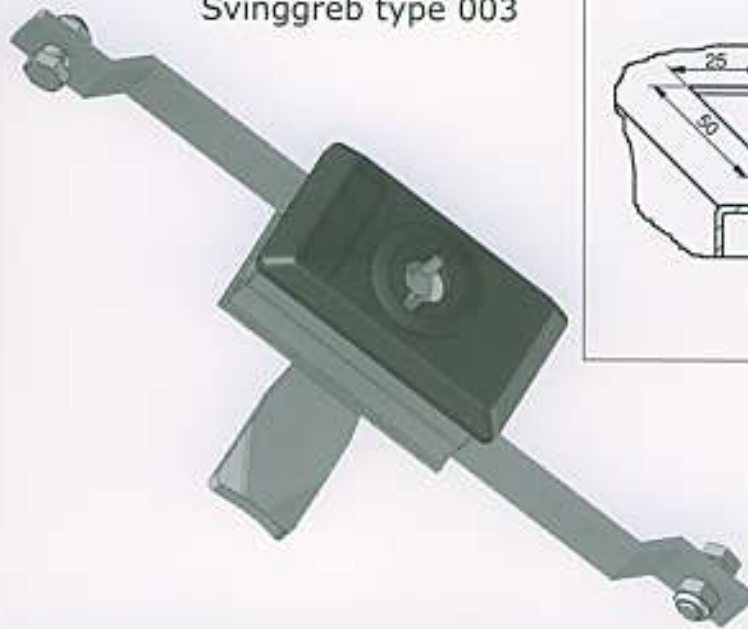

Svinggreb type 005



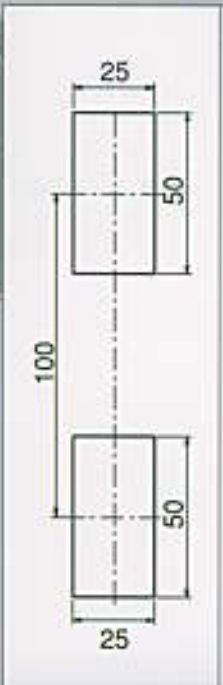
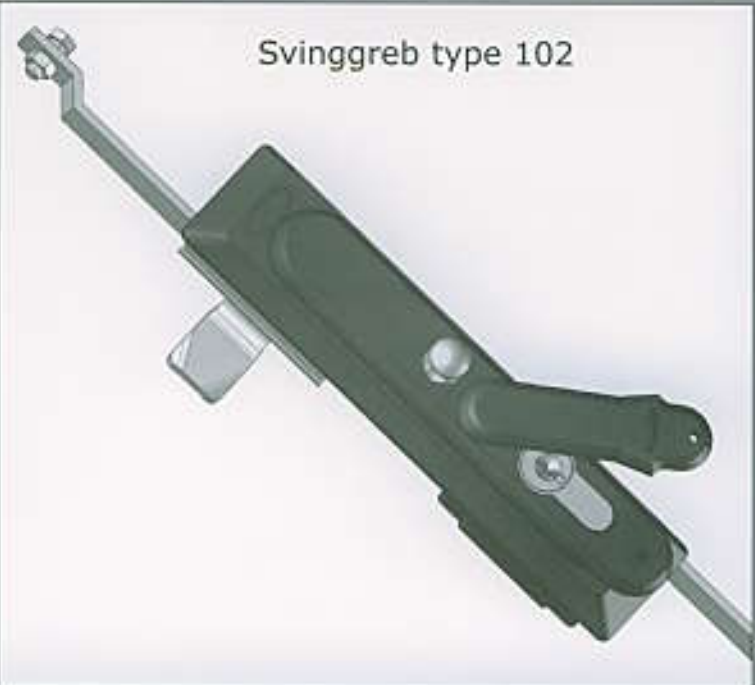
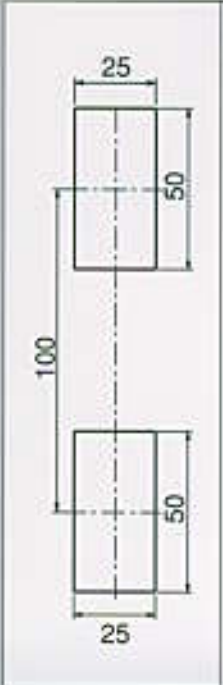
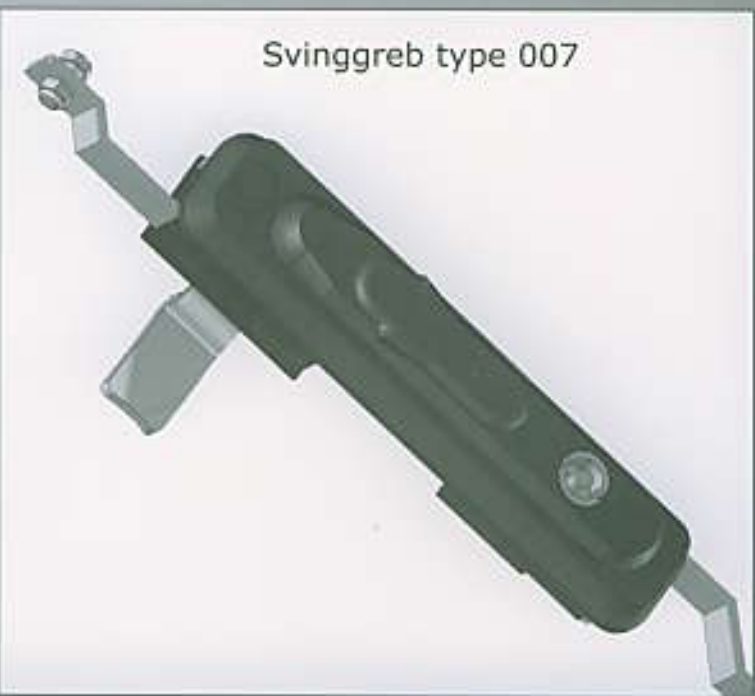
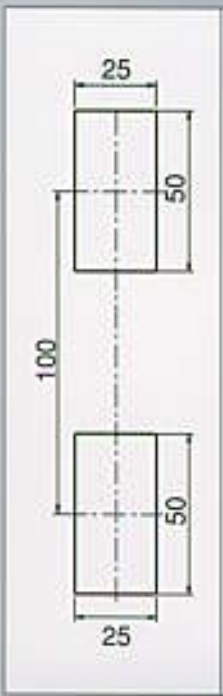

www.praestmark.dk

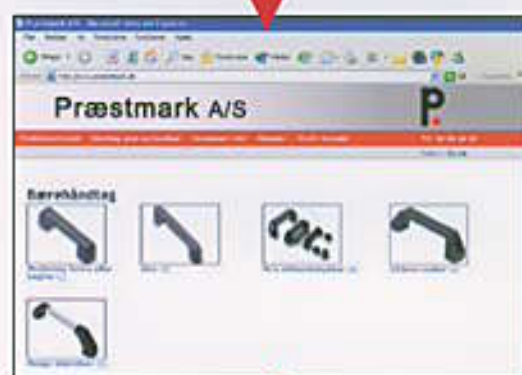

Præstmark A/S

Transformervej 21

DK-2730 Herlev

Telefon +45 38 88 44 00

Fax +45 38 11 44 00

info@praestmark.dk

sales@praestmark.dk

accounts@praestmark.dk

